

BY	CHK	REVISION RECORD MODIFICATIONS	DATE	REV.
ALLEN		RELEASE TO PRODUCTION	2007,9,10	1.0

**MATERIAL:**  
 Insulator Material: P.B.T, UL 94V-0  
 Contact Material: Copper alloy  
 Finish: Tin plated  
 For CR1250

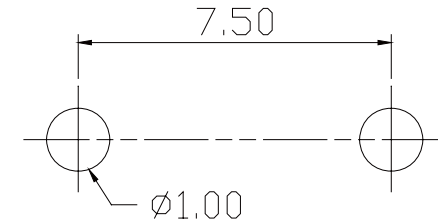

Recommended PCB Layout  
 (PCB TOLERANCE±0.05)

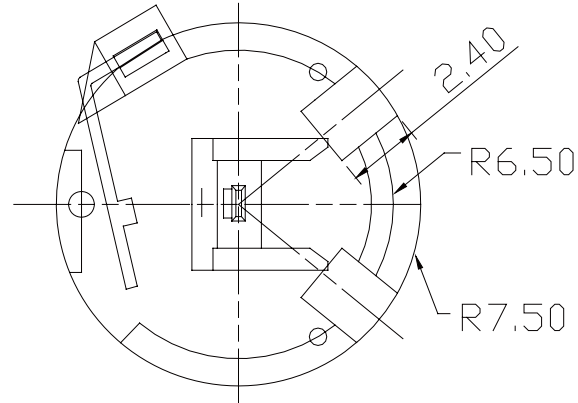
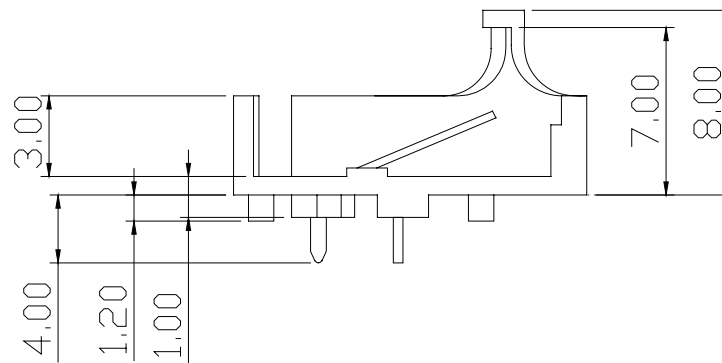

PartNo.:BTD-1250TB-L

APPRO	CHECK	DRAWN	PART NO.	Part No.:BTD-1250TB-L	DESCRIPTION	
			ITEM NO.			
			DRAW NO.			
			UNIT	mm SCALE no		
			TOLER	NO.		
			Tel: 0769 22020068 Fax: 0769 22020069 E-mail: sales@vigortec.com			